

THE PROPERTY OF THE DRAWING IS ESTABLISHED BY LAW. IT IS FORBIDDEN TO PRODUCE OR SHOW IT TO THIRD PART, WITHOUT A WRITTEN AGREEMENT.

Item	Name	Q.ty
1	CA.08.03.004	1
2	CA.08.09.009	1

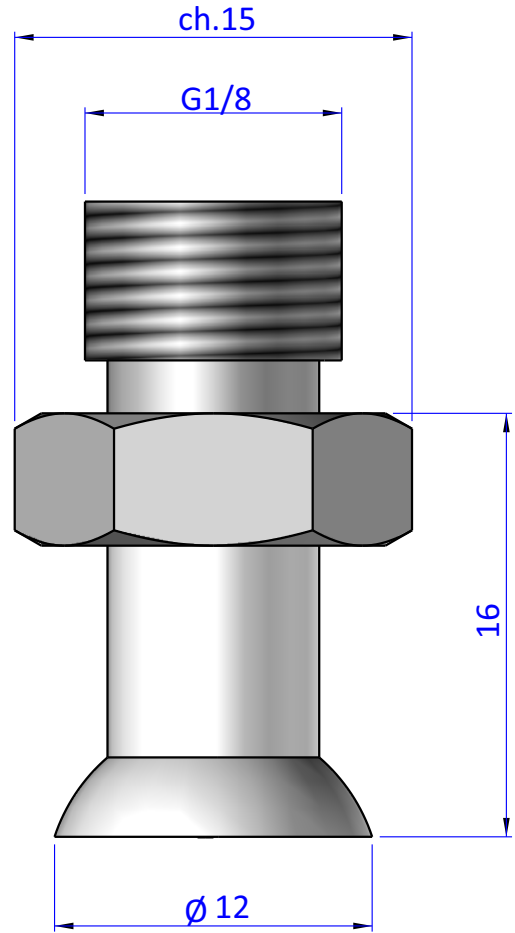
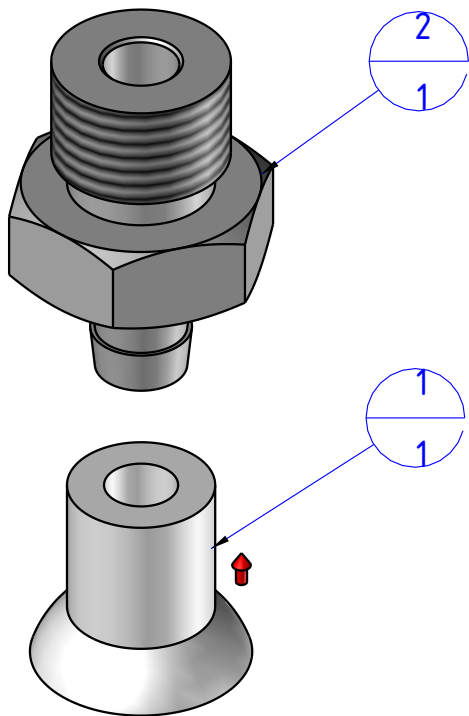

DESIGNED FROM	REVIEW
FPS Automation	A

DATE	WEIGHT
04/11/2020	0,004kg

CODE
KIT.08.03.D12.9

Format A4
UNI 936-76

GENERAL TOLERANCE
UNI - ISO 2768
CLASSE f

DESCRIPTION
KIT.08.03.D12.9